

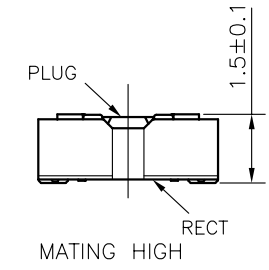

A B C D E F

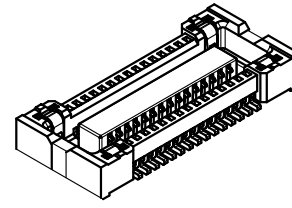
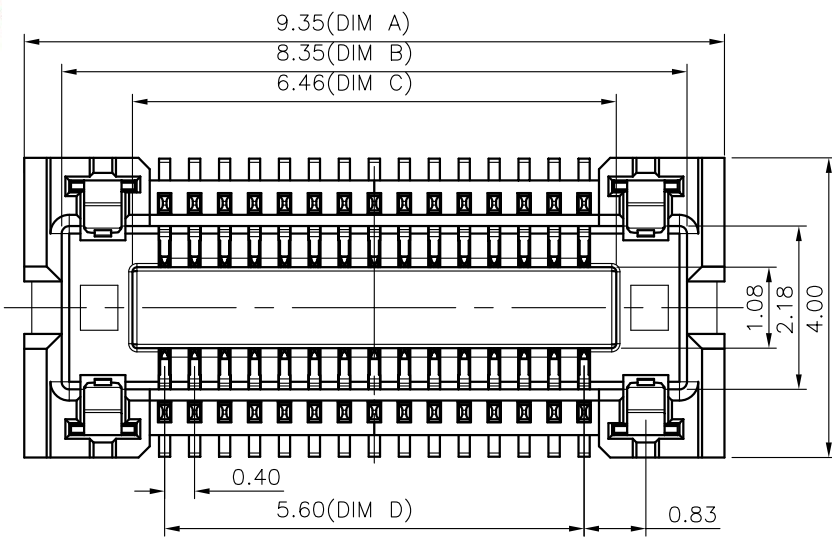

- NOTES:
- MATERIAL:
 - HOUSING: THERMOPLASTIC, HIGH TEMP UL94V-0; COLOR: BLACK
 - CONTACT: PHOSPHOR BRONZE
 - FITTING: COPPER ALLOY
 - FINISH
 - CONTACT:
 - 50u" MIN. NICKEL UNDERPLATING OVERALL
 - GOLD FLASH PLATING OVERALL
 - SOLDER
 - 50u" MIN. NICKEL UNDERPLATING OVERALL
 - GOLD FLASH PLATING OVERALL
 - FITTING NAIL:
 - 50u" MIN. NICKEL UNDERPLATING OVERALL
 - N: 100u" MIN, MATT TIN UNDERPLATING OVERALL
 - REFLOW SOLDER CAPABLE TO 260°C PER ACES SPEC.
 - SPEC. PLS. REFER TO PS-51150-XXXX-XXX
 - PACKAGE PLS. REFER TO 51151-XXXX-00-TRP
 - MATING CONNECTOR P/N 51150-XXXX-XXX
 - PART NUMBER

51151-XXX X X -XXX	
CKTS	001-WITHOUT BOST
PACKAGE	CONTACT PLATED
4.TAPE & REEL WITH MYLAR	1.GOLD FLASH ON CONTACT

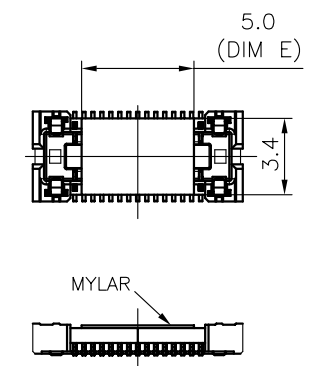
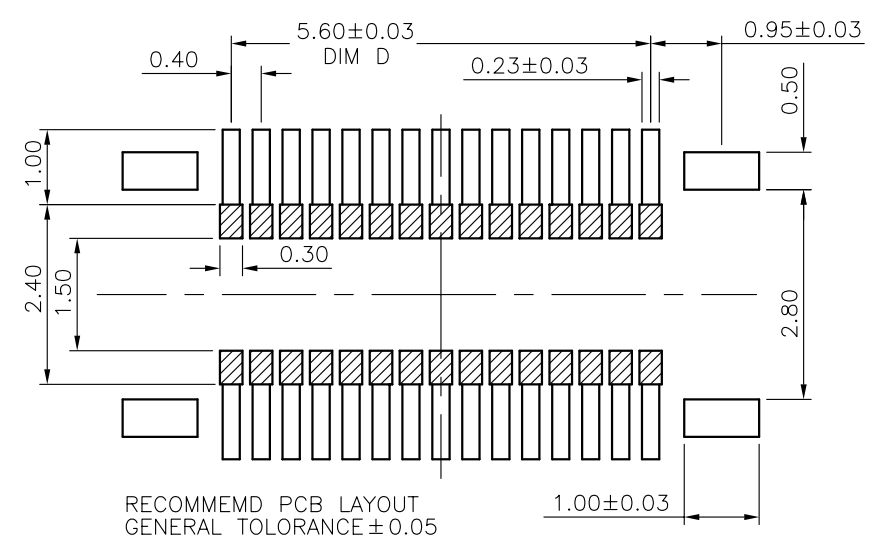
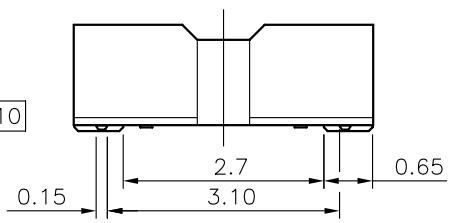
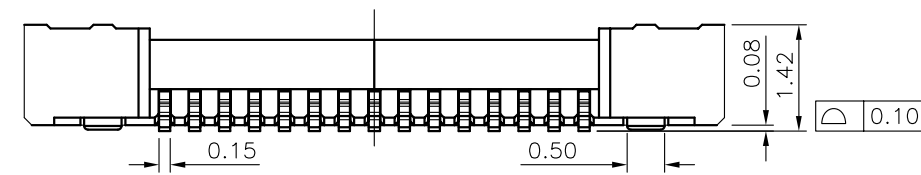

30	9.40	8.35	6.46	5.60	5.0
CKT	DIM A	DIM B	DIM C	DIM D	DIM E

一般公差 TOLERANCES X ±0.50 .XX ±0.15 X ±0.25 .XXX ±0.10 ANGLES ±2°		宏致電子股份有限公司 Aces Electronics Co.,Ltd.	
檢驗尺寸標示 SYMBOLS ⊕ ⊗ INDICATE CLASSIFICATION DIMENSION ⊕ MARK IS CRITICAL DIM. ⊗ MARK IS MAJOR DIM.	品名 (TITLE) 0.4 BTB RECP CONN.	製圖 (DR) '16/11/08 審核 (CHKD) BRAVE	ZHUWEI
	圖號 (DWG.NO) 51151-xxxxx-xxx-ACES	核准 (APPD) FRANK	
表面處理 (FINISH)	比例 (SCALE) 單位 (UNITS) 10:1 mm	張數 (SHEET) 1 OF 1	SIZE REV A4 A

1

2

3

4

5

1

2

3

4

5

A B C D E F